

iW3616

AC/DC Digital Power Controller for High Power Factor Dimmable LED Drivers



1.0 Features

- Isolated/non-isolated offline $120V_{AC}/230V_{AC}$ LED driver up to 12W output power
- Wide line frequency ranges (from 45Hz to 66Hz)
- Meets IEC61000-3-2 requirement
- Total harmonic distortion < 15% with PF > 0.95
- Wide dimmer compatibility
 - » Leading-edge dimmer
 - » Trailing-edge dimmer
 - » Digital dimmer
 - » Occupancy sensors and timers
- Under 20% output ripple current
- Wide dimming range from 1% to 100%
- Flickerless™ LED dimming
- Resonant control to achieve high efficiency (typical > 85% without dimmer)
- Over-temperature LED current foldback
- Small solution size
 - » Two-stage topology enables small-size input and output filter capacitors
 - » 200kHz maximum switching frequency enables small transformer
 - » Intelligent dimmer interface eliminates dedicated high-power bleeder
- Primary-side sensing eliminates the need for opto-isolator feedback
- Tight LED current regulation ($\pm 5\%$)
- Fast start-up (< 0.5s without dimmer)
- Supports hot-plug LED module (Zhaga)
- Compatible with NEMA SSL6 dimming curve standard
- Supports wide LED output voltage range
- Multiple protection features:
 - » LED open-circuit and short-circuit protection
 - » Over-current and over-temperature protection
 - » Current sense resistor short-circuit protection
 - » AC line over-voltage/-frequency protection

2.0 Description

The iW3616 is a two-stage, high-performance AC/DC offline power supply controller for dimmable LED luminaires. It applies advanced digital control technology to detect the dimmer type and phase, which provides dynamic impedance to interface the dimmer and control the LED brightness at the same time. The iW3616 uses iWatt's unique digital Flickerless™ technology to eliminate visible flicker in the entire dimming range and minimize low frequency output ripple current.

With advanced dimmer detection technology, the iW3616 can operate with most wall dimmers including leading-edge dimmers (R-type or R-L type) and trailing-edge dimmers (R-C type). In addition, the iW3616's cycle-by-cycle waveform analysis technology allows fast dimmer setting response. When no dimmer is on the line, the iW3616 optimizes the power factor and minimizes the current harmonic distortion to the AC line.

The iW3616 operates the main power converter that delivers constant current to the LED load in quasi-resonant mode to provide high power efficiency and minimize electro-magnetic interference (EMI). It uses iWatt's patented PrimAccurate™ primary-side sensing technology to achieve excellent LED current regulation under different AC line and LED load voltages, without using a secondary-side feedback circuit and eliminating the need for an opto-coupler.

The iW3616 minimizes the external components count by simplifying the EMI filter with iWatt's EZ-EMI® technology. The intelligent dimmer detection technology eliminates the need for a high-power bleeder. Additionally, the digital control loop of the iW3616 maintains stable overall operating conditions without the need for loop compensation components.

3.0 Applications

- Dimmable LED retrofit lamps up to 12W
- Dimmable LED ballast and luminaires up to 12W



iW3616

AC/DC Digital Power Controller for High Power Factor Dimmable LED Drivers

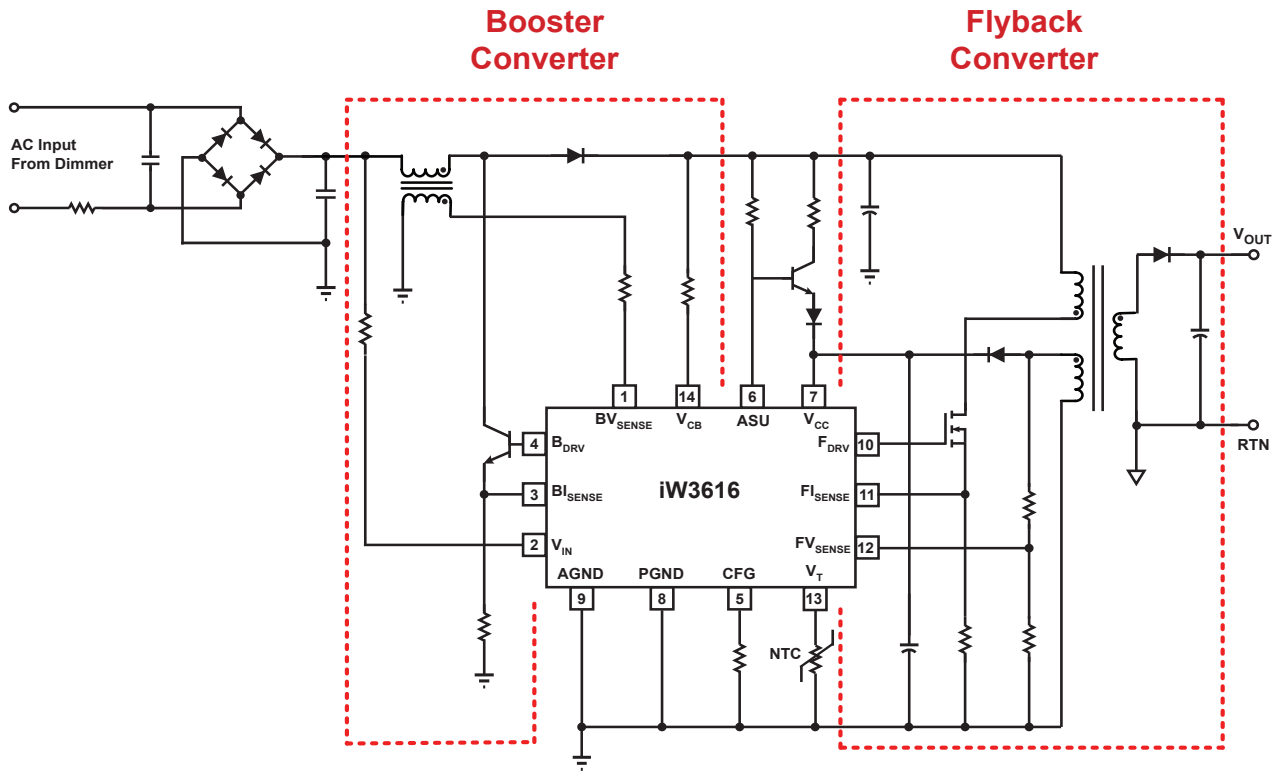

Figure 3.1 : iW3616 Simplified Schematic

iW3616

AC/DC Digital Power Controller for High Power Factor Dimmable LED Drivers



4.0 Pinout Description

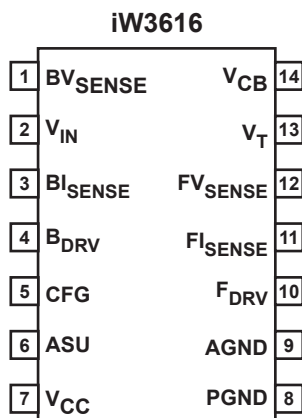

Pin #	Name	Type	Pin Description
1	BV _{SENSE}	Analog Input	Boost inductor voltage feedback input
2	V _{IN}	Analog Input	Rectified AC line voltage input
3	BI _{SENSE}	Analog Input	Boost current sense input
4	B _{DRV}	Output	Base drive output for boost BJT
5	CFG	Analog In/Out	Driver parameter configuration pin and auxiliary driver
6	ASU	Output	Active start-up and bleeder control
7	V _{CC}	Power	Power supply for control logic and voltage sense for power-on reset circuit
8	PGND	Ground	Power ground
9	AGND	Ground	Signal ground. It should be connected to the power ground on PCB.
10	F _{DRV}	Output	Gate drive output for flyback MOSFET
11	FI _{SENSE}	Analog Input	Flyback current sense (used for cycle-by-cycle peak current control and limit)
12	FV _{SENSE}	Analog Input	Flyback voltage sense (used for primary-side regulation and ZVS)
13	V _T	Analog Input	External power limit shutdown control and external over-temperature power derating
14	V _{CB}	Analog Input	Boost output voltage feedback input

iW3616

AC/DC Digital Power Controller for High Power Factor Dimmable LED Drivers



5.0 Absolute Maximum Ratings

Absolute maximum ratings are the parameter values or ranges which can cause permanent damage if exceeded. For maximum safe operating conditions, refer to Electrical Characteristics in Section 6.0.

Parameter	Symbol	Value	Units
DC supply voltage range (pin 7, $I_{CC} = 20\text{mA max}$)	V_{CC}	-0.3 to 18	V
DC supply current at V_{CC} pin	I_{CC}	20	mA
F_{DRV} output (pin 10)		-0.3 to 18	V
B_{DRV} output (pin 4)		-0.3 to 4.0	V
CFG input (pin 5)		-0.3 to 4.0	V
CFG output (pin 5)		-0.3 to 18	V
FV_{SENSE} input (pin 12, $I \leq 10\text{mA}$)		-0.7 to 4.0	V
BV_{SENSE} input (pin 1, $I \leq 3\text{mA}$)		-0.7 to 4.0	V
V_{IN} input (pin 2)		-0.3 to 18	V
V_{CB} input (pin 14)		-0.3 to 18	V
FI_{SENSE} input (pin 11)		-0.3 to 4.0	V
BI_{SENSE} input (pin 3)		-0.3 to 4.0	V
ASU output (pin 6)		-0.3 to 18	V
V_T input (pin 13)		-0.3 to 4.0	V
Power dissipation at $T_A \leq 25^\circ\text{C}$		900	mW
Maximum junction temperature	$T_{J\text{ MAX}}$	150	$^\circ\text{C}$
Storage temperature	T_{STG}	-65 to 150	$^\circ\text{C}$
Lead temperature during IR reflow for ≤ 15 seconds	T_{LEAD}	260	$^\circ\text{C}$
Thermal Resistance Junction-to-PCB Board Surface Temperature	ψ_{JB} (Note 1)	45	$^\circ\text{C/W}$
ESD rating per JEDEC JESD22-A114		2,000	V
Latch-up test per JEDEC 78		± 100	mA

Notes:

Note 1. ψ_{JB} [Psi Junction to Board] provides an estimation of the die junction temperature relative to the PCB surface temperature. This data is measured at the ground pins (pin 8 and pin 9) without using any thermal adhesives.

iW3616

AC/DC Digital Power Controller for High Power Factor Dimmable LED Drivers



6.0 Electrical Characteristics

$V_{CC} = 12\text{ V}$, $-40^{\circ}\text{C} \leq T_A \leq 85^{\circ}\text{C}$, unless otherwise specified (Note 1)

Parameter	Symbol	Test Conditions	Min	Typ	Max	Unit
V_{IN} SECTION						
Start-up voltage threshold -01	V_{IN_ST}	$T_A = 25^{\circ}\text{C}$, positive edge	0.826	0.918	1.01	V
Start-up voltage threshold -00	V_{IN_ST}	$T_A = 25^{\circ}\text{C}$, positive edge	0.972	1.08	1.188	V
Over-voltage shutdown threshold	V_{IN_OVP}	$T_A = 25^{\circ}\text{C}$, positive edge	1.512	1.68	1.848	V
Input impedance	Z_{IN}	After start-up		5		k Ω
V_{IN} range	V_{IN}		0		1.8	V
V_{CB} SECTION						
Over-voltage shutdown threshold	V_{CB_OVP}	$T_A = 25^{\circ}\text{C}$, positive edge	1.62	1.8	1.98	V
Input impedance	Z_{CB}	After start-up		15		k Ω
V_{CB} range	V_{CB}		0		1.8	V
FV_{SENSE} SECTION						
Input leakage current	$I_{BVS(FVSENSE)}$	$V_{SENSE} = 2\text{V}$			1	μA
Normal voltage threshold	$V_{SENSE(NOM)}$	$T_A = 25^{\circ}\text{C}$, negative edge	1.521	1.536	1.551	V
Output OVP threshold (default)	$V_{SENSE(MAX)}$	$T_A = 25^{\circ}\text{C}$, negative edge	1.683	1.7	1.717	V
BV_{SENSE} SECTION						
Input leakage current	$I_{BVS(BVSENSE)}$	$V_{SENSE} = 0.1\text{V}$			1	μA
F_{DRV} SECTION						
Output low level ON-resistance	$R_{DS_ON_LO(FDRV)}$	$I_{SINK} = 5\text{mA}$		16		Ω
Output high level ON-resistance	$R_{DS_ON_HI(FDRV)}$	$I_{SOURCE} = 5\text{mA}$		25		Ω
Maximum switching frequency (Note 2)	$f_{SW_FDRV(MAX)}$			200		kHz
B_{DRV} SECTION						
Output low level ON-resistance	$R_{DS_ON_LO(BDRV)}$	$I_{SINK} = 5\text{mA}$		1		Ω
Maximum switching frequency (Note 2)	$f_{SW_BDRV(MAX)}$	if $V_{IN_A} < 130\text{mV}$		200		kHz
		if $V_{IN_A} > 130\text{mV}$		90		kHz

iW3616

AC/DC Digital Power Controller for High Power Factor Dimmable LED Drivers



6.0 Electrical Characteristics (cont.)

$V_{CC} = 12\text{ V}$, $-40^{\circ}\text{C} \leq T_A \leq 85^{\circ}\text{C}$, unless otherwise specified (Note 1)

Parameter	Symbol	Test Conditions	Min	Typ	Max	Unit
ASU SECTION						
Maximum operating voltage	$V_{ASU(MAX)}$				18	V
Resistance between V_{CC} and ASU	R_{VCC_ASU}			830		k Ω
V_{CC} SECTION						
Maximum operating voltage	$V_{CC(MAX)}$				17	V
Start-up threshold	$V_{CC(ST)}$		11.5	12.5	13.5	V
Under-voltage lockout threshold	$V_{CC(UVL)}$		6.0	6.5	7.0	V
Operating current	I_{CCQ}			6.5		mA
ASU turn-off threshold	$V_{CC_ASU_OFF}$			16.25		V
FI_{SENSE} SECTION						
CC regulation threshold limit	$V_{REG_TH(FLYBACK)}$			1.4		V
I_{SENSE} short protection reference	$V_{RSENSE(FLYBACK)}$			0.16		V
Over-current limit threshold	$V_{OCP(FLYBACK)}$			1.5		V
BI_{SENSE} SECTION						
Current sink regulation threshold low limit -01	$V_{REG_TH(LO)}$			0.68		V
Current sink regulation threshold low limit -00	$V_{REG_TH(LO)}$			0.34		V
Current sink regulation threshold high limit -01	$V_{REG_TH(HI)}$			0.92		V
Current sink regulation threshold high limit -00	$V_{REG_TH(HI)}$			0.46		V
I_{SENSE} short protection reference	$V_{RSENSE(BOOST)}$			0.15		V
Over-current limit threshold	$V_{OCP(BOOST)}$			1.9		V
V_T SECTION						
Power limit high threshold (Note 3)	$V_{P_LIM(HI)}$			0.56		V
Power limit low threshold (Note 3)	$V_{P_LIM(LO)}$			0.44		V
Shutdown threshold (Note 3)	V_{SH_TH}			0.22		V
Input leakage current	$I_{BVS(VT)}$	$V_{VT} = 1.0\text{V}$			1	μA

iW3616

AC/DC Digital Power Controller for High Power Factor Dimmable LED Drivers



6.0 Electrical Characteristics (cont.)

$V_{CC} = 12\text{ V}$, $-40^{\circ}\text{C} \leq T_A \leq 85^{\circ}\text{C}$, unless otherwise specified (Note 1)

Parameter	Symbol	Test Conditions	Min	Typ	Max	Unit
Pull-up current source	I_{VT}		90	100	110	μA
CFG SECTION						
Pull-up current source	I_{CFG}		90	100	110	μA
Output low level ON-resistance	$R_{DS_ON_LO(CFG)}$	$I_{SINK} = 5\text{mA}$		30		Ω
Output high level ON-resistance	$R_{DS_ON_HI(CFG)}$	$I_{SOURCE} = 5\text{mA}$		50		Ω

Notes:

Note 1. Adjust V_{CC} above the start-up threshold before setting at 12V.

Note 2. Operating frequency varies based on the line and load conditions. See the Theory of Operation section for more details.

Note 3. These parameters refer to digital preset values, and they are not 100% tested.

iW3616

AC/DC Digital Power Controller for High Power Factor Dimmable LED Drivers



7.0 Typical Performance Characteristics

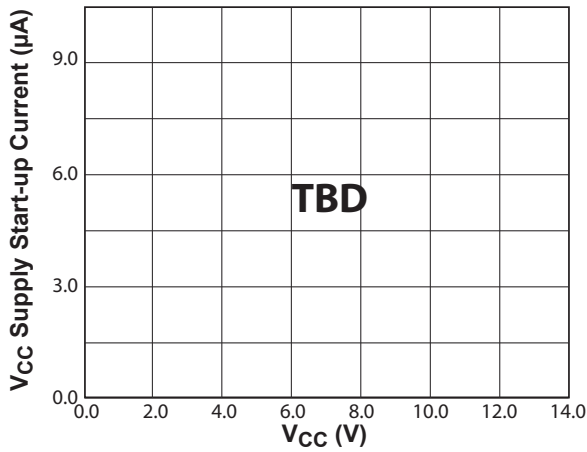

Figure 7.1 : V_{CC} vs. V_{CC} Supply Start-up Current

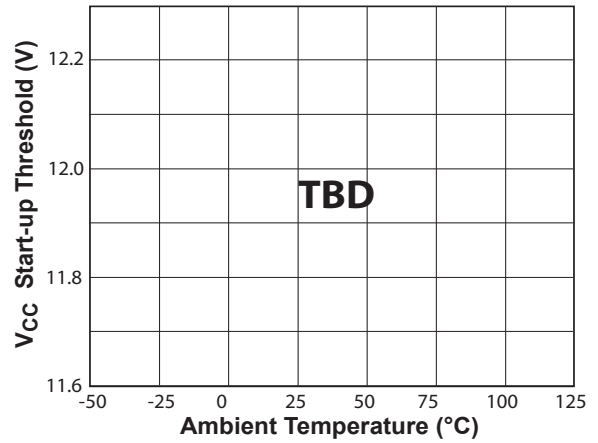

Figure 7.2 : Start-Up Threshold vs. Temperature

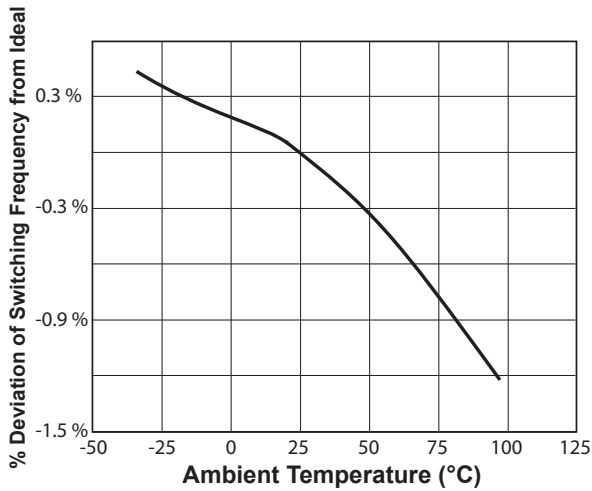

Figure 7.3 : % Deviation of Switching Frequency to Ideal Switching Frequency vs. Temperature

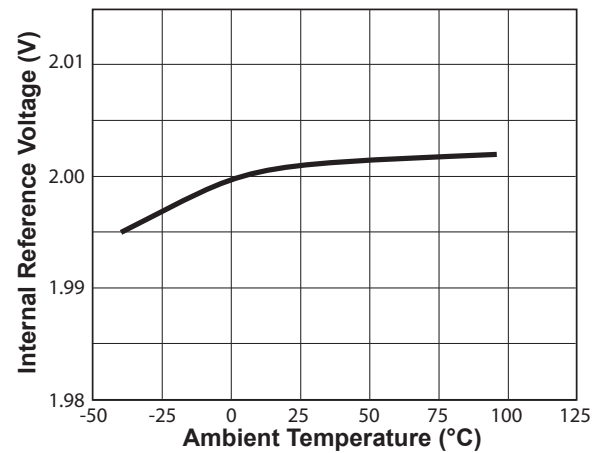

Figure 7.4 : Internal Reference vs. Temperature

9.0 Theory of Operation

9.1 System Start Up

This section provides information about iW3616 system start up, which include the IC startup, wall dimmer detection, and the LED current soft start.

9.1.1 IC Startup

When AC voltage is applied, the boost output capacitor in (C3 in Figure 11.1) is charged to the peak of line voltage. ASU pin is open by default so that ASU BJT (Q3 in Figure 11.1) is turned on and V_{CC} capacitors (C8 and C9 in Figure 11.1) is charged through ASU resistor (R9 in Figure 11.1) and ASU BJT. When the V_{CC} voltage reaches start-up threshold $V_{CC(ST)}$, the iW3616's control logic is activated and the IC starts up. The ASU pin is kept open and the ASU circuit continues charging V_{CC} until 50ms after the main flyback converter starts.

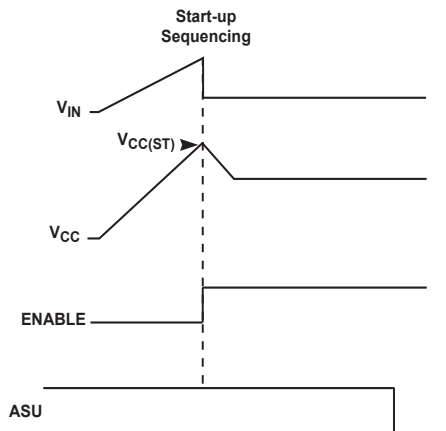

Figure 9.1 : Start-up Sequencing Diagram

9.1.2 Wall Dimmer Detection

There are two basic categories of phase-cut wall dimmers: leading-edge dimmers and trailing-edge dimmers. If the AC voltage rises at the phase-cut edge, the dimmer is called leading-edge dimmer (shown in Figure 9.2). Otherwise it is called trailing-edge dimmer (shown in Figure 9.3). Normally speaking, leading-edge dimmer is TRIAC based (R-type, RL-type); trailing-edge dimmer is MOSFET or IGBT based (RC-type).

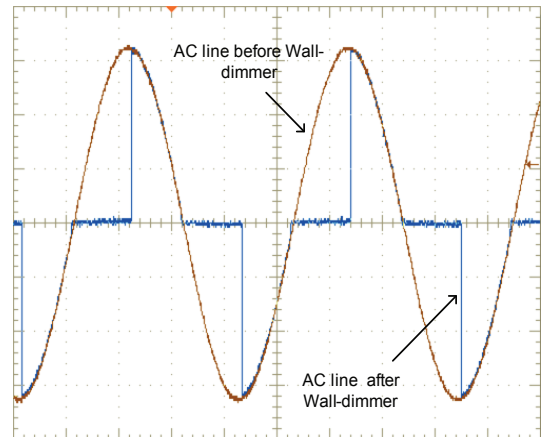

Figure 9.2 : Leading-Edge Wall Dimmer Waveforms

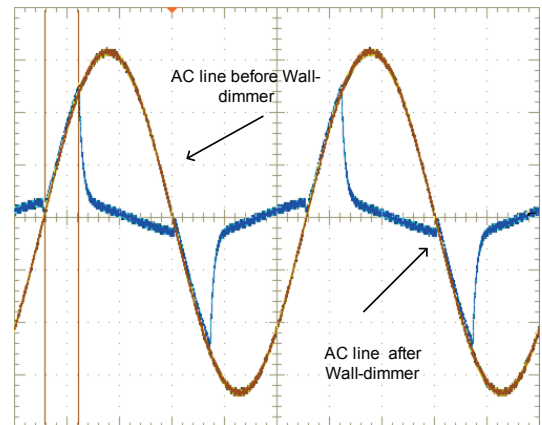

Figure 9.3 : Trailing-Edge Wall Dimmer Waveforms

The dimmer detection stage occurs in the iW3616 immediately after IC starts up. The iW3616 is driving the boost BJT (Q2 in Figure 11.1) constantly on to do current sinking during the wall dimmer detection. The purposes of current sinking at startup are:

- Calibrate the sinking current to 200mA to compensate for the BJT gain variation. This 200mA current sinking is used to latch the leading-edge dimmer during the phase-cut in normal operation.
- Place a low impedance resistance on the AC line to accurately detect whether a dimmer is connected and the type of dimmer connected.

The dimmer type can be determined by looking at the derivative of the input AC voltage. A large positive derivative value indicates a leading-edge dimmer. Otherwise, trailing-edge dimmer or no dimmer is detected.

iW3616

AC/DC Digital Power Controller for High Power Factor Dimmable LED Drivers



Once the dimmer type is determined, the iW3616 needs to qualify the AC input signal before delivering current to the LED load. If under any condition the iW3616 does not see the peak of V_{IN} signal above $V_{IN_ST(MIN)}$ for two consecutive AC half-cycles or the AC line frequency is out of range, the AC input signal is considered as unqualified. The iW3616 will continuously monitor the AC input signal until it sees a qualified AC input signal and then starts to deliver current to the LED load. Or if the V_{CC} drops under $V_{CC(UVL)}$ in this process, the iW3616 will reset and the V_{CC} voltage will charge up again for a fresh start-up.

9.1.3 LED Current Soft-Start

After the iW3616 qualifies the AC input signal, the flyback converter will immediately start to deliver constant current to the LED load. A soft-start algorithm is applied to the flyback converter to gradually ramp up the LED current, thus reducing the stress on the LEDs. If no dimmer or a trailing-edge dimmer is detected, the output current will ramp up to the target current level within several AC half cycles. If a leading-edge dimmer is detected, the ramp up of the LED current is slower to avoid current over-shoot or under-shoot. This is because the leading-edge dimmer's phase conduction angle is usually not stable when the load on the dimmer is light.

If a dimmer is connected, the boost converter will start immediately into leading-edge or trailing-edge mode operation (refer to Section 9.31 and 9.32 for details) to interface the dimmer. If no dimmer is connected, the boost converter will start PFC operation (refer to Section 9.33 for details).

9.2 Phase Measurement and Dimming Curve

This section provides information about iW3616 phase measurement and dimming curve.

9.2.1 Phase Measurement

Dimmer phase conduction angle is measured every AC half cycle. Dimmer phase is determined by the time period that V_{IN} stays above the zero-crossing threshold (t_{CROSS}) as shown in Figure 9.4. The threshold is 140mV.

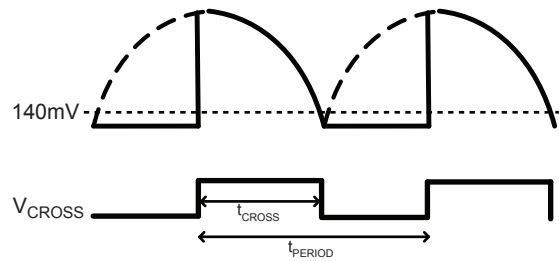

Figure 9.4 : Dimmer Phase Measurement

And the dimmer phase ratio (D ratio) is calculated as:

$$\text{Dimmer Phase Ratio (D ratio)} = t_{CROSS} / t_{PERIOD} \quad (9.1)$$

The t_{PERIOD} is the period of AC half cycle, which is measured by the time span between the moments that V_{IN} rises above the 140mV reference in two consecutive AC half cycles. If the D ratio is above 90%, the iW3616 considers no dimmer is on the line.

9.2.2 Dimming Curve

The iW3616 dims the LED by reducing the output current to a certain percentage of the LED current level when there is no dimmer, which is called dimming percentage. A mapping between the D ratio and the dimming percentage is pre-determined in the iW3616. There are two different mapping options, or dimming curves, that can be selected with the CFG pin (refer to Section 9.5 for details). Both dimming curves fall within the limits of the NEMA SSL6 standard (as shown in Figure 10.6). The iW3616 updates the dimming percentage based on the D ratio measurement every AC half cycle to ensure fast dimmer response.

9.3 Dimmer Interface and Power Factor Correction Block Operation

This section provides information about iW3616 dimmer interface and power factor correction block's operation, which includes leading-edge dimmer mode, trailing-edge dimmer mode, no dimmer mode, and transition between these operation modes.

9.3.1 Leading-Edge Dimmer Mode

If a leading-edge dimmer is detected on the line, the boost converter is operated in leading-edge dimmer mode. This mode provides dynamic impedance matching for the leading-edge dimmers. The leading-edge mode operation can be split into five intervals, as shown in Figure 9.5.

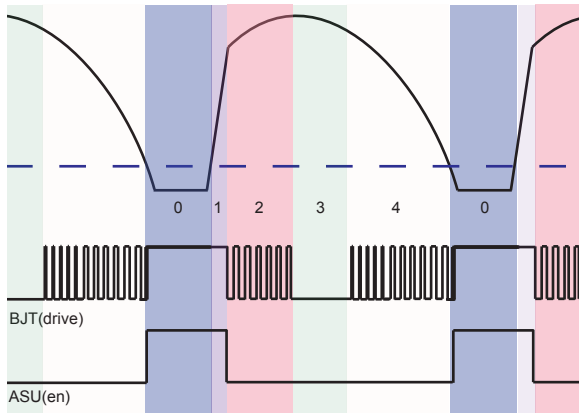

Figure 9.5 : Leading-Edge Boost Mode Operation

During interval 0, the TRIAC in the leading-edge dimmer is turned off and the dimmer requires a low impedance load to charge its internal timing circuit. The boost BJT (Q2 in Figure 11.1) is driven in current sink mode to provide such low impedance load. When the TRIAC inside the dimmer is fired, the operation enters interval 1. Interval 1 is a short period of time after the TRIAC fires. The boost BJT is kept in current sink mode to provide 200mA latching current for the TRIAC. Then the operation enters interval 2. The boost BJT is in switching mode during interval 2. Interval 2 ends at 90° of the phase angle. During Interval 2, the iW3616 boosts the energy into the boost output capacitor and provides the holding current of the TRIAC at the same time. Interval 3 is a 400µs blanking time to ensure the TRIAC turns off after enough energy is boosted into the boost output capacitor. Then the operation enters interval 4 in which the boost BJT is in light duty-cycle switching mode to discharge the EMI filter capacitors of the LED driver.

9.3.2 Trailing-Edge Dimmer Mode

If a trailing-edge dimmer is detected on the line, the boost converter is operated in trailing-edge dimmer mode. This mode provides dynamic impedance matching for trailing-edge dimmers. The operation can be split into four intervals, as shown in Figure 9.6.

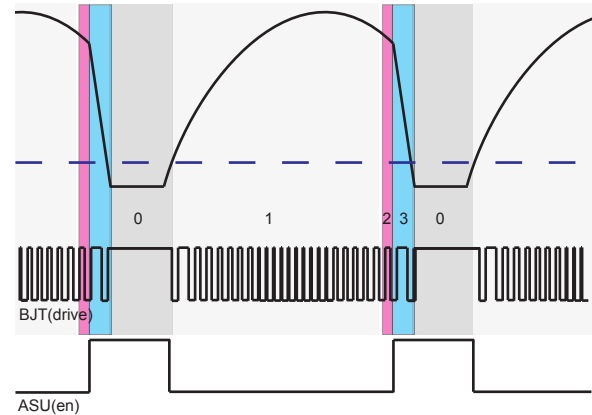

Figure 9.6 : Trailing-Edge Boost Mode Operation

During interval 0, the boost BJT is driven in current sink mode to reset the dimmer with a low impedance load. Interval 1 begins as the V_{IN} rises above the zero crossing reference. The boost BJT is driven in switching mode to boost energy into the boost output capacitor. Then interval 2 starts at a short period of time before the phase-cut edge to increase the switching duty cycle as a transition state between interval 1 and interval 3. Interval 3 begins right at the phase-cut edge. The boost BJT switches with four times of the duty cycle as in interval 1 to quickly discharge the EMI capacitor inside the dimmer so as to ensure the accurate phase.

9.3.3 No Dimmer Mode (PFC Operation)

If there is no dimmer on the line, boost converter is operated in PFC mode for optimal power factor and minimum harmonic distortion. The iW3616 switches the boost BJT in valley mode switching to minimize the switching loss and EMI. Input current will follow the input voltage as shown in Figure 9.7.

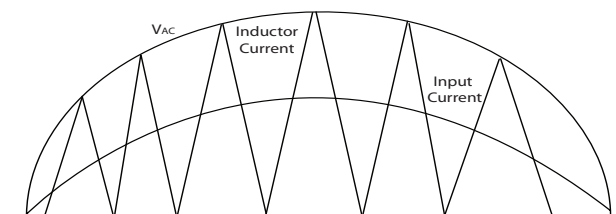

Figure 9.7 : No Dimmer Boost Mode Operation

The iW3616's PFC algorithm is based on fixed on-time switching with the compensation of dead-time after the boost inductor resets. The dead-time is measured from the moment that boost inductor resets (determined by BV_{SENSE}).

pin) to the following boost BJT turn-on moment (determined by B_{DRV} pin). To maximize the power efficiency, the boost output capacitor voltage is set to be 30V above the peak AC line voltage for 230V AC input and 15V above for 120V AC input.

9.3.4 Transition Between Operation Modes

The iW3616 constantly monitors the derivative of the V_{IN} signal every AC half cycles to ensure the boost converter's operation is in the correct mode. The mode of the operation is continuously updated based on the latest detected dimmer type.

The iW3616 also monitors dimmer existence by looking at the D ratio. If the D ratio is greater than 90% at any time, the boost converter will enter the No Dimmer mode immediately.

9.4 LED Current Regulation and Dimming Control Block Operation

This section provides information about iW3616 LED current regulation and dimming control block operation.

9.4.1 Cycle-by-Cycle LED Current Regulation

The LED current regulation and dimming control block incorporates the iWatt-patented PrimAccurate™ technology. Constant current is guaranteed regardless of the input voltage (boost output capacitor voltage) or the output voltage (LED load forward voltage) of the flyback converter. Figure 9.8 shows the basic principle of this constant current regulation algorithm.

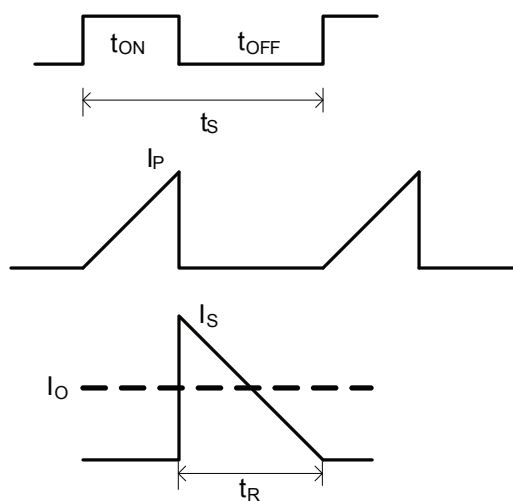

Figure 9.8 : Constant Current Regulation

The flyback converter is operated in critical discontinuous conduction mode (CDCM). When the flyback MOSFET (Q1 in Figure 11.1) turns on, the transformer primary winding

current ramps up linearly and energy builds up in the transformer. The iW3616 turns off the MOSFET when the primary winding current reaches the peak current regulation level. At this moment, the transformer maintains the magnetic flux so that the energy in the transformer generates the secondary winding current that equals to the peak primary winding current multiplied by primary-secondary turns-ratio. Then the secondary winding current ramps down linearly until all the energy in transformer is discharged. After the energy in the transformer is discharged, the iW3616 starts the next switching cycle. The LED load current is the average of the saw-tooth shaped secondary winding current.

The LED load current can be determined by an equation as shown below.

$$I_{OUT} = 0.5 \times N_{TR} \times I_{PK} \times T_R / T_P \quad (9.2)$$

where I_{PK} is the peak of primary winding current. N_{TR} is the primary-secondary turns ratio. T_R is the secondary winding current ramp-down time, or the transformer reset time. T_P is the entire switching period.

The I_{PK} is determined by the voltage generated on the current-sense resistor: $I_{PK} = V_{PK} / R_S$. Therefore, the equation can be written as:

$$I_{OUT} = 0.5 \times N_{TR} / R_S \times (V_{PK} \times T_R / T_P) \quad (9.3)$$

The iW3616 measures T_R and T_P on a cycle-by-cycle basis and controls V_{PK} so that the $K_{CC} = V_{PK} \times T_R / T_P$ is always a constant. The K_{CC} is an internally defined constant that equals to 0.7V. Therefore, the I_{OUT} can be determined by the turns-ratio and current sense resistor at the design time of the application circuit.

9.4.2 Dimming Control

iW3616 has two dimming scheme options which can be selected by the CFG pin (refer to Section 9.5 for details). The first one is pulse width modulation (PWM) dimming. The second one is constant current pulse frequency modulation (CC-PFM) dimming.

- PWM Dimming Mode

From 100% to 25% dimming percentage, the iW3616 employs the same constant current regulation algorithm as described in section 9.4.1 while reducing the K_{CC} constant. As a result, the I_{OUT} will proportionally decrease as the K_{CC} decreases. In this process, the switching frequency of the flyback converter will increase. The maximum switching frequency is clamped at 200kHz.

At 25% dimming percentage, the iW3616 will clamp the K_{CC} value and switch to the 630Hz PWM dimming. Further

iW3616

AC/DC Digital Power Controller for High Power Factor Dimmable LED Drivers



dimming is achieved by only activating the flyback converter during a certain percentage of time in every 630Hz period.

- CC-PFM Dimming Mode

From 100% to 25% dimming percentage, the iW3616 operates in the same K_{CC} -reduction dimming method as described in PWM dimming, except that the frequency clamp changes linearly from 200kHz at 100% dimming percentage to 50kHz at 25% dimming percentage. Below 25% dimming percentage, the iW3616 will switch to the CC-PFM mode, which keeps the V_{PK} a constant and increase the T_p to achieve further dimming.

9.5 CFG Pin

The CFG pin is used to select between the two dimming modes (described in Section 9.42) and the two dimming curves (see Figure 10.6). At startup, the CFG pin outputs I_{CFG} after V_{CC} reaches $V_{CC(ST)}$. The iW3616 reads the CFG pin voltage after 40 μ s. The dimming curve and dimming mode are selected by connecting a resistor with different values to the CFG pin as shown in Table 9.1

CFG Option Number	CFG Pin Resistor		Dimming Curve Number (Fig. 10.6)	Dimming Control
	Value	Tolerance		
1	20k Ω	$\leq 5\%$	1	PWM
2	12.7k Ω	$\leq 5\%$	1	CC-PFM
3	8.87k Ω	$\leq 5\%$	2	PWM
4	5.62k Ω	$\leq 5\%$	2	CC-PFM

Table 9.1 CFG Pin Resistor

9.6 Protection Features

This section provides information about iW3616 protection features.

9.6.1 Output Over-Voltage/LED Open Protection

The iW3616 includes a function that protects against an output over-voltage.

The output voltage is monitored by the FV_{SENSE} pin. The ratio between the FV_{SENSE} pin voltage and output voltage is equal to the transformer auxiliary to secondary winding turns-ratio multiplied by the FV_{SENSE} resistor divider ratio (R_{20} , R_{21} in Figure 11.1). If the voltage at the FV_{SENSE} pin exceeds $V_{SENSE(MAX)}$, the iW3616 shuts down immediately. After the shutdown, the iW3616 remains powered which discharges the V_{CC} . In order to avoid over-charging the output voltage,

the iW3616 employs an extended discharge time as described below.

Under the fault condition, the iW3616 tries to start up for three consecutive times. If all three start-up attempts fail, the iW3616 enters the inactive mode, during which the iW3616 does not respond to the V_{CC} power-on requests. The iW3616 is activated again after it sees 29 start-up attempts. The iW3616 can also be reset to the initial condition if the V_{CC} is completely discharged. Typically, this extended discharge time is around three to five seconds, and it allows the iW3616 to support hot-plug LED modules without causing output over-voltage while maintaining a quick recovery.

9.6.2 Output Short Protection

The iW3616 includes a function that protects against an output short-circuit fault.

If the voltage at the FV_{SENSE} pin is below 0.228V, the iW3616 shuts down immediately. After the shutdown, the iW3616 remains powered, which discharges the V_{CC} . In order to avoid excessive power stress due to auto-restart, the iW3616 employs an extended discharge time (as described in Section 9.61).

To support applications with high output capacitance, output short protection is not activated in the initial LED current soft start period. This allows the voltage to build up in the output capacitor without mis-triggering the protection.

9.6.3 Over-Temperature Protection

If an NTC thermistor is connected between the V_T pin and the GND, the iW3616 is able to detect and protect against an over-temperature event.

The iW3616 provides an I_{VT} to the V_T pin and detects the voltage on the pin. Based on this voltage, the iW3616 can monitor the resistance of the NTC thermistor, which is related to the temperature of the thermistor. As the V_T pin voltage reduces, the iW3616 reduces the power in boost and flyback converter. There is a hysteresis of 84mV on the V_T pin voltage for each power limiting step.

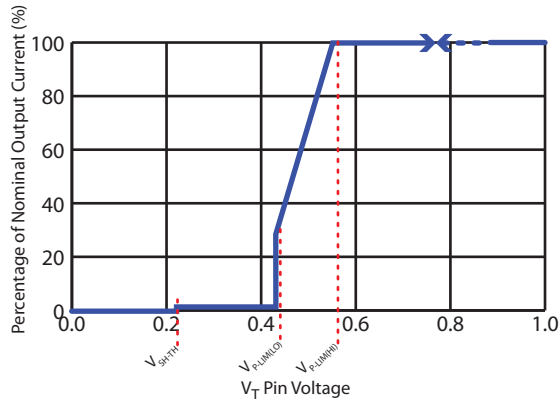

Figure 9.9 : V_T Pin Voltage vs. % of Nominal Output Current

When the V_T pin voltage reaches $V_{P-LIM(HI)}$ the output current begins to reduce linearly from 100% to 30% as shown in Figure 9.9. At $V_{P-LIM(LO)}$ the output current will be clamped to 1%. If the V_T pin voltage further decreases to below V_{SH_TH} , the iW3616 will shut down.

The iW3616 will remain in shut-down mode as long as the V_T pin voltage is below V_{SH_TH} . If the V_T pin voltage rises above V_{SH_TH} at any time, the device will start up and the output will be clamped at 1%. Once the V_T pin voltage reaches $V_{P-LIM(LO)}$, the output current will increase to 30%. From $V_{P-LIM(LO)}$ to $V_{P-LIM(HI)}$, the output current will increase linearly from 30% to 100% as shown in Figure 9.9. Finally, the device will go back to normal operation when the V_T pin voltage rises above $V_{P-LIM(HI)}$.

This bi-directional operation of the V_T pin enables the LED current thermal foldback instead of an abrupt shut-down of the light. As the output power decreases under the mild over-temperature condition, the amount of heat generated by the LED also decreases, which reduces the possibility of further temperature rise of the system.

When there is a dimmer on the line, the thermal foldback is disabled. The iW3616 will shut down the boost converter and clamp the output current to 1% as soon as the V_T pin voltage is below $V_{P-LIM(HI)}$, for safety reasons.

9.6.4 Over-Current Protection

Over-current protection (OCP) is a feature that is built into the iW3616.

With the FI_{SENSE} pin the iW3616 is able to monitor the primary peak current of the flyback converter. This allows for cycle-by-cycle peak current control and limit. When the primary peak current multiplied by the FI_{SENSE} sense resistor (R_{15} in Figure 11.1) is greater than $V_{OCP(FLYBACK)}$, over-current is detected and the iW3616 immediately turns off the gate drive until the next cycle. The F_{DRV} pin sends out switching

pulse in the next cycle, and the switching pulse continues if the $V_{OCP(FLYBACK)}$ is not reached; or, the switching pulse turns off again if the $V_{OCP(FLYBACK)}$ is still reached.

The BI_{SENSE} pin provides the same protection mechanism for the boost converter. The BI_{SENSE} OCP threshold is $V_{OCP(BOOST)}$ in no dimmer or trailing-edge dimmer mode. The BI_{SENSE} OCP threshold is 1.5V in leading-edge dimmer mode.

9.6.5 Sense Resistor Short Protection

If the FI_{SENSE} sense resistor is shorted there is a potential danger of the over-current condition not being detected. Thus the iW3616 is designed to detect this sense-resistor short fault. If the voltage on the FI_{SENSE} pin is below $V_{RS(SENSE)}$ after $15.6\mu s$ of turning on, the sense-resistor short protection is triggered and the iW3616 shuts down immediately. After the shutdown, the V_{CC} is discharged since the iW3616 remains powered. The iW3616 employs an extended discharge time (as described in Section 9.6.1) before restart.

If the BI_{SENSE} resistor is shorted, the iW3616 cannot determine the emitter current of the boost BJT, which can ultimately result in the boost BJT exceeding its safe operating area. Thus the iW3616 is designed to detect this boost sense-resistor short fault. When the iW3616 detects a boost-sense-resistor short fault at the detection cycle, the iW3616 shuts down immediately. In the leading-edge and trailing-edge modes, the detection cycle is the zero crossing period in an AC half cycle. If there is no dimmer on the line, the only detection cycle is at start-up. After the shutdown, the V_{CC} is discharged since the iW3616 remains powered. To prevent over-stress on the boost circuit components, the iW3616 employs an extended discharge time (as described in Section 9.6.1) before restart.

9.6.6 Boost Inductor Short-Protection

The boost inductor is protected from short condition in no dimmer mode. If the BV_{SENSE} pin is not able to see the reset of the boost inductor, the boost inductor short is detected. The iW3616 will short down immediately.

9.6.7 AC Input and Boost Output Over-Voltage Protection

The iW3616 supports the over-voltage protection of AC input and boost output voltage.

If the V_{IN} pin voltage is higher than V_{IN_OVP} for continuous 2ms within every 16ms period, and this condition lasts for eight consecutive AC half cycles, the iW3616 shuts down both the boost and flyback converters. After the shutdown,

iW3616

AC/DC Digital Power Controller for High Power Factor Dimmable LED Drivers



the V_{CC} is discharged since the iW3616 remains powered. When V_{CC} drops below $V_{CC(UVL)}$, the iW3616 resets itself and then initiates a new soft-start cycle.

If the V_{CB} pin voltage is higher than V_{CB_OVP} for continuous 128ms, then the iW3616 shuts down both the boost and flyback converters. After the shutdown, the V_{CC} is discharged since the iW3616 remains powered. When V_{CC} drops below $V_{CC(UVL)}$, the iW3616 resets itself and then initiates a new start cycle.

Under both the input and boost output over-voltage fault condition, the iW3616 employs an extended discharge time (as described in Section 9.61) before restart.

iW3616

AC/DC Digital Power Controller for High Power Factor Dimmable LED Drivers



10.0 Performance Characteristics

Trailing-Edge Dimmer

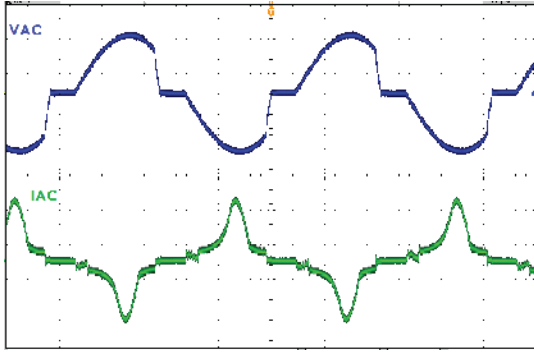

Time (4.0ms/div)

Figure 10.1 : Trailing-Edge Dimmer

Trailing-Edge Dimmer

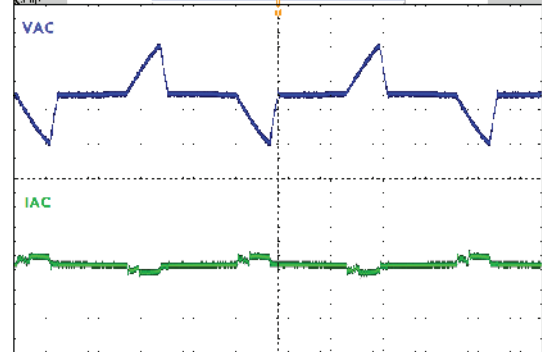

Time (4.0ms/div)

Figure 10.2 : Trailing-Edge Dimmer 2

Leading-Edge Dimmer

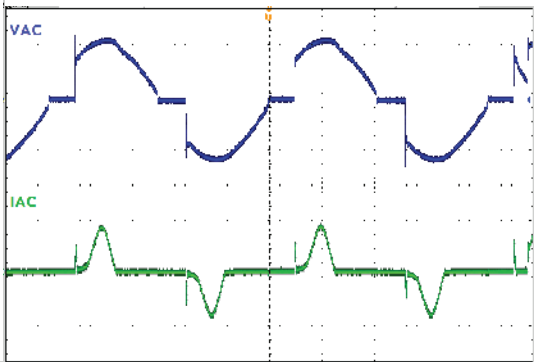

Time (4.0ms/div)

Figure 10.3 : Leading-Edge Dimmer

Leading-Edge Dimmer

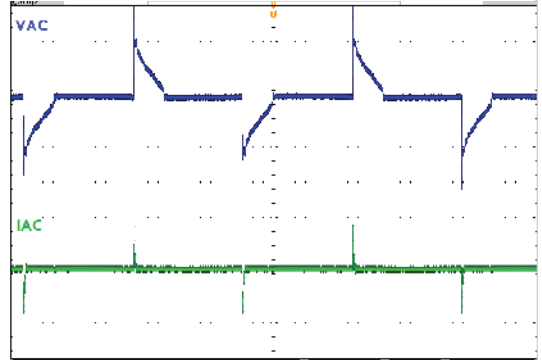

Time (4.0ms/div)

Figure 10.4 : Leading-Edge Dimmer 2

No Dimmer

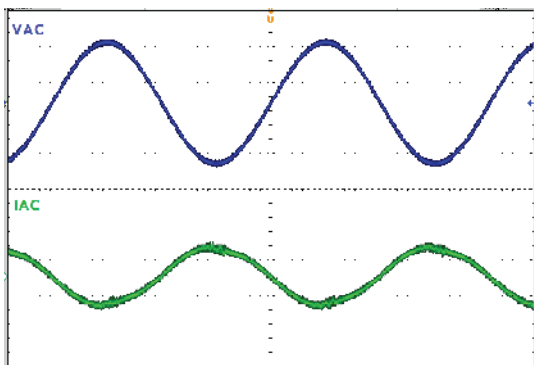

Time (4.0ms/div)

Figure 10.5 : No Dimmer

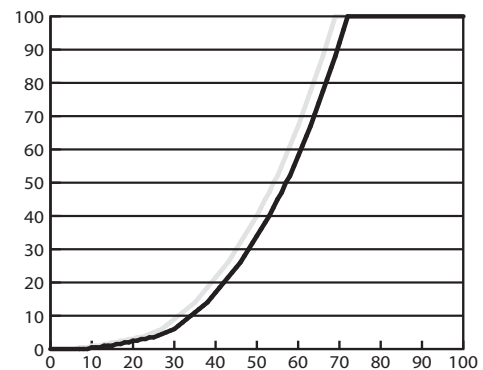

Dimmer Input Phase (%) — Option 1 — Option 2

Figure 10.6 : Dimming Curve

iW3616

AC/DC Digital Power Controller for High Power Factor Dimmable LED Drivers



11.0 Typical Application Schematic

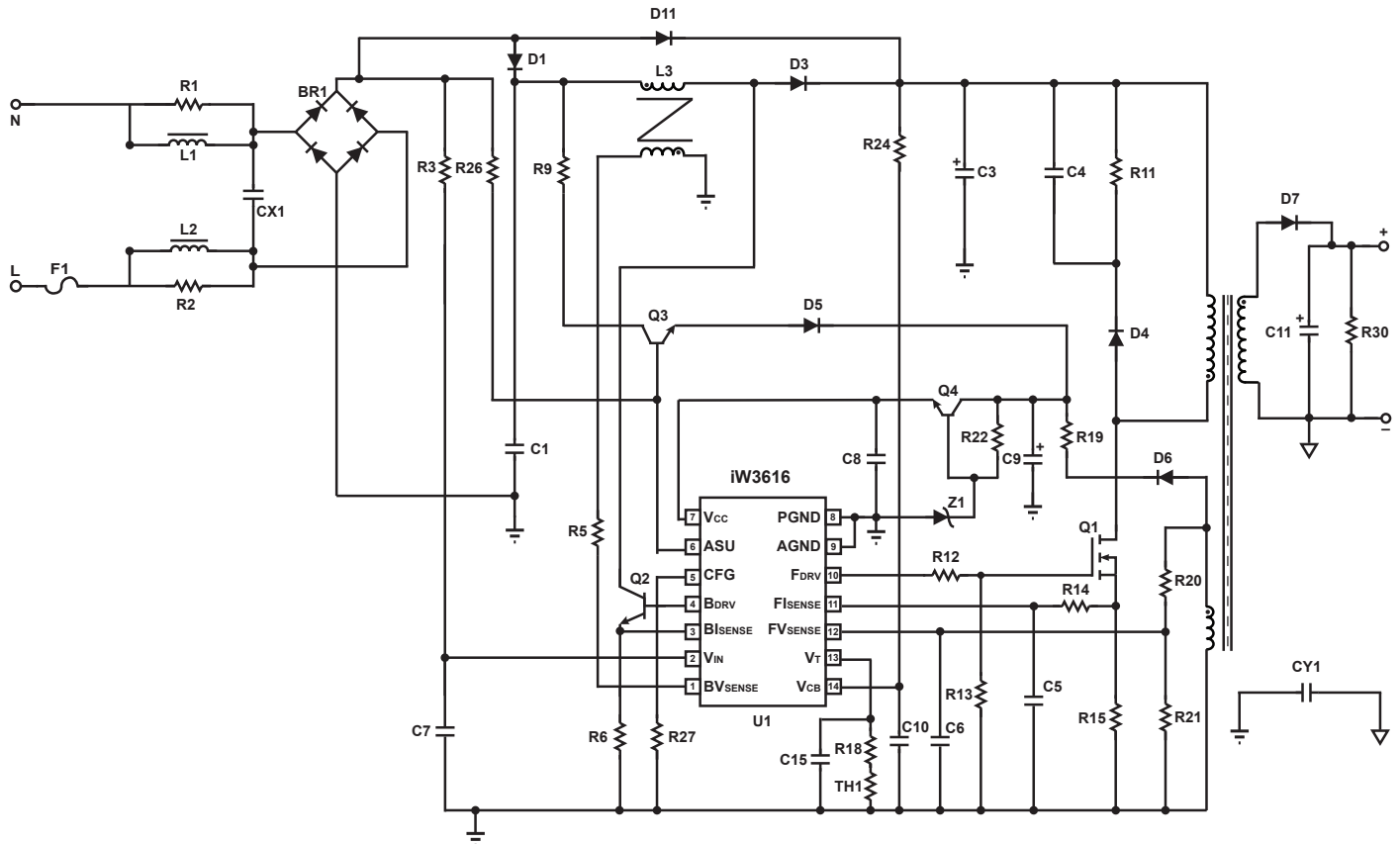

Figure 11.1 : iW3616 Typical Application Circuit

iW3616

AC/DC Digital Power Controller for High Power Factor Dimmable LED Drivers



12.0 Physical Dimensions

14-Lead SOIC Package

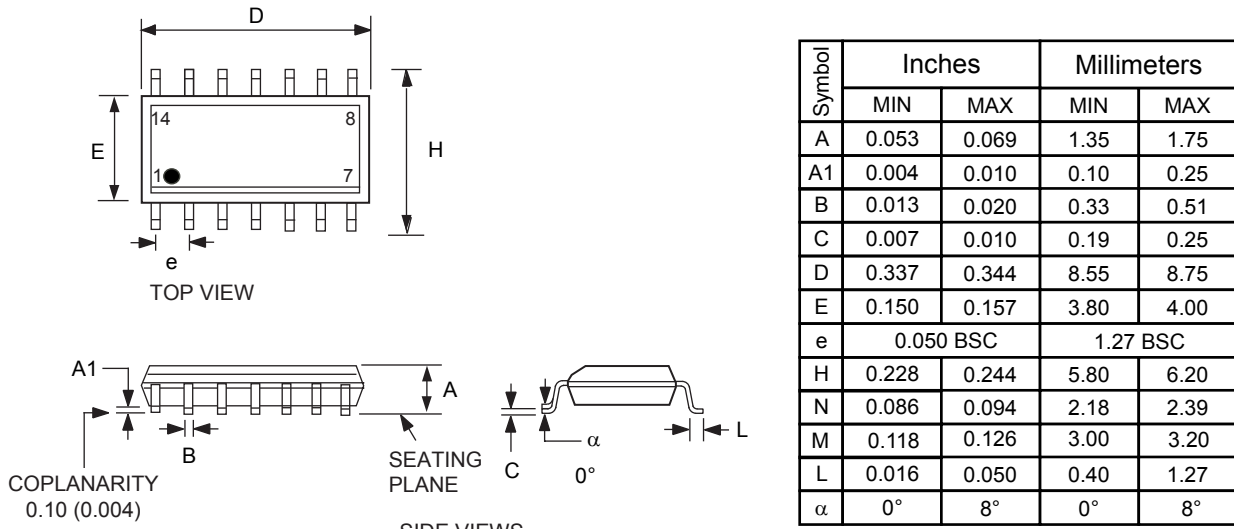

Figure 12.1 : Physical dimensions, 8-lead SOIC package

Compliant to JEDEC Standard MS12F

Controlling dimensions are in inches; millimeter dimensions are for reference only

This product is RoHS compliant and Halide free.

Soldering Temperature Resistance:

[a] Package is IPC/JEDEC Std 020D Moisture Sensitivity Level 1

[b] Package exceeds JEDEC Std No. 22-A111 for Solder Immersion Resistance; package can withstand 10 s immersion < 270°C

Dimension D does not include mold flash, protrusions or gate burrs. Mold flash, protrusions or gate burrs shall not exceed 0.15 mm per end. Dimension E does not include interlead flash or protrusion. Interlead flash or protrusion shall not exceed 0.25 mm per side.

The package top may be smaller than the package bottom. Dimensions D and E are determined at the outermost extremes of the plastic body exclusive of mold flash, tie bar burrs, gate burrs and interlead flash, but including any mismatch between the top and bottom of the plastic body.

13.0 Ordering Information

Part Number	Options	Package	Description
iW3616-00	120V _{AC} Input	SOIC-14	Tape & Reel ¹
iW3616-01	230V _{AC} Input	SOIC-14	Tape & Reel ¹

Note 1: Tape & Reel packing quantity is 2,500/reel.

iW3616

AC/DC Digital Power Controller for High Power Factor Dimmable LED Drivers



Trademark Information

© 2012 iWatt Inc. All rights reserved. iWatt, BroadLED, *EZ-EMI*, Flickerless, Intelligent AC-DC and LED Power, and PrimAccurate are trademarks of iWatt Inc. All other trademarks and registered trademarks are the property of their respective owners.

Contact Information

Web: <https://www.iwatt.com>

E-mail: info@iwatt.com

Phone: +1 (408) 374-4200

Fax: +1 (408) 341-0455

iWatt Inc.

675 Campbell Technology Parkway, Suite 150
Campbell, CA 95008

Disclaimer and Legal Notices

iWatt reserves the right to make changes to its products and to discontinue products without notice. The applications information, schematic diagrams, and other reference information included herein is provided as a design aid only and are therefore provided as-is. iWatt makes no warranties with respect to this information and disclaims any implied warranties of merchantability or non-infringement of third-party intellectual property rights.

This product is covered by the following patents: 6,385,059; 6,730,039; 6,862,198; 6,900,995; 6,956,750; 6,990,900; 7,443,700; 7,505,287; 7,589,983; 6,972,969; 7,724,547; 7,876,582; 7,880,447; 7,974,109; 8,018,743; 8,049,481; 7,936,132; 7,433,211; 6,944,034. A full list of iWatt patents can be found at www.iwatt.com.

Certain applications using semiconductor products may involve potential risks of death, personal injury, or severe property or environmental damage ("Critical Applications").

iWATT SEMICONDUCTOR PRODUCTS ARE NOT DESIGNED, INTENDED, AUTHORIZED, OR WARRANTED TO BE SUITABLE FOR USE IN LIFE-SUPPORT APPLICATIONS, DEVICES OR SYSTEMS, OR OTHER CRITICAL APPLICATIONS.

Inclusion of iWatt products in critical applications is understood to be fully at the risk of the customer. Questions concerning potential risk applications should be directed to iWatt Inc.

iWatt semiconductors are typically used in power supplies in which high voltages are present during operation. High-voltage safety precautions should be observed in design and operation to minimize the chance of injury.